

3254-12/S-TR

3254-12/S-SN-TR

3254-12/C-TR

3254-12/C-SN-TR

DURCHSTECKFASSUNG FÜR T8-T12 LEUCHTSTOFFRÖHREN
TOMBSTONE LAMPHOLDERS FOR T8-T12 FLUORESCENT LINEAR LAMPS

Technische Daten

Technical data







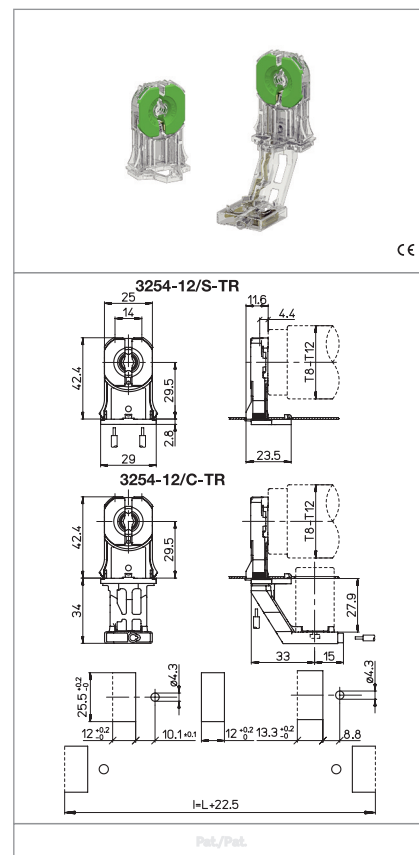

- Lampensockel - Lamp cap	G13
- Nennstrom und Nennspannung - Rated current and voltage	2A-500V
- Maximale Betriebstemperatur (IEC) - Maximum operating temperature (IEC)	T140 Tm110
- Schutzgrad - Protection index	IP20
- Überspannungskategorie - Impulse withstand category	II

Merkmale

Characteristics

- Gehäuse aus polycarbonat, transparent
- Transparent polycarbonate body
- Kupferlegierte Kontakte
- Copper alloy contacts
- Mit Top Test
- With top test



 Durchsteckbefestigung push-through fixing	 Blechstärke zur Befestigung fixing metal plate thickness 0,4-2	 Lichtpunkthöhe ab Unterseite leuchtenblech lamp centre height (from the bottom of the metal plate) 29,5	 Ausführung ohne Haltezapfen version without stop nib
 Rotor aus PBT in grün in Rastposition... PBT green rotor with position of... 90°	 Steckkontakte mit 2 Löchern push-wire terminals with 2 holes	 Feste Leitungsabschnitte rigid conductor section 0,5-1	 Leitungsabsicherung rigid wires stripping 8-10

Prüfzeichen
Quality marks

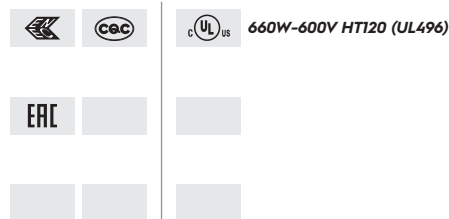

Europäische Richtlinien
European directives

gemäß "RoHS"
"RoHS" compliant
unterliegt nicht "WEEE"
Not subject to "WEEE"

Gewichte und Verpackung
Weights and packaging

Artikel/Art. Produktreihe Product references	g Nettogewicht Net weight	n° pz pro Beutel per bag	n° pz pro Box per box	n° pz pro Karton per carton
3254-12/S-TR	6,3	500		
3254-12/S-SN-TR	6,3	500		
3254-12/C-TR	11,2	250		
3254-12/C-SN-TR	11,2	250		

Bemerkung

Notes